

### Description

Alloy Thermal-Link / Alloy Thermal Cutoff (ATCO) is defined as a non-resettable protective device functioning one time only. It is widely used in electrical equipment. ATCO is mainly consist of fusible alloy, flux resin, case, sealant and lead wires. Normally, fusible alloy is jointed to the two lead wires. Under abnormal conditions, when the temp. reaches to the fusing temp. of ATCO, the fusible alloy melts and quickly retracts to the two lead wire ends with the aid of the flux resin and disconnects the circuit completely.

### Features

- Transparent Plastic Case
- Non-Resettable
- High Accuracy of Functioning Temp.
- RoHS & REACH Compliant

### Applications

- Lamps
- Switched-Mode Power Supplies
- Home Electrical Appliances
- Transformers
- Motors
- Batteries

### Customization





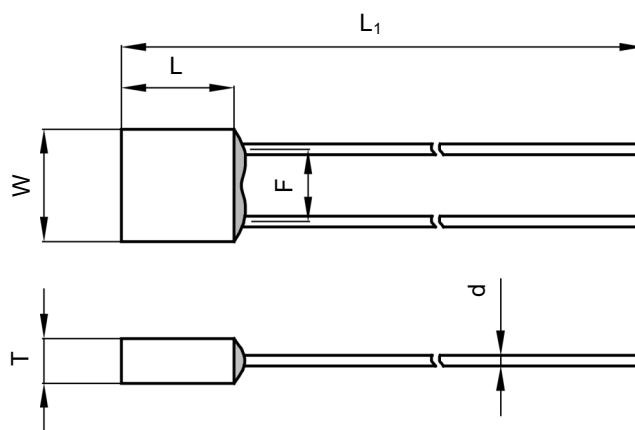

- Other Temp.
- The Length of Lead Wires
- Taping Packing Available
- Lead Wires can be Insulated
- Tinned Copper Wires or CP Wires

### Dimensions (mm)



L	L <sub>1</sub>	W	T	d	F
4.2 ± 0.5	70.0 ± 3.0	5.1 ± 0.5	2.3 ± 0.2	0.50 ± 0.05	3.2 ± 0.5

### Agency Approvals

Agency	Standards	File No.
	UL 60691	E214712
	CAN-CSA-E60691	E214712
	EN 60691	R50161758
	EN 60691	40004041
	J60691	PSE16021063 PSE16021064 PSE16021065 PSE16021066 PSE16021067 PSE16021068
	K60691	SU05023-6002A SU05023-6003B
	GB/T 9816	2020980205000190

ATCO

ATCO

### Structure Diagrams



### Marking

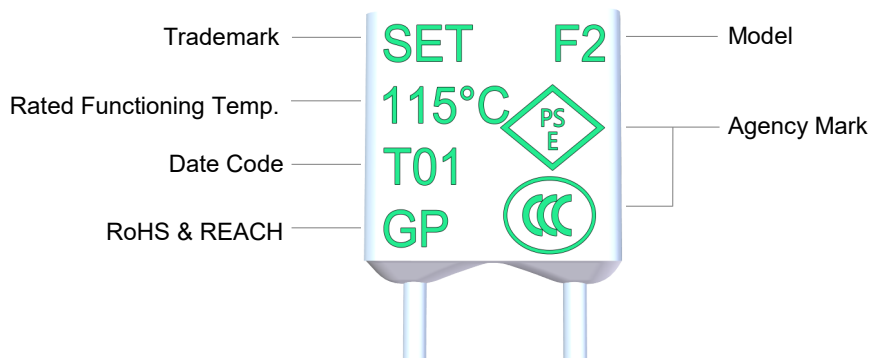

### Part Numbering System

ATCO - F 2 - A N N A B - 001

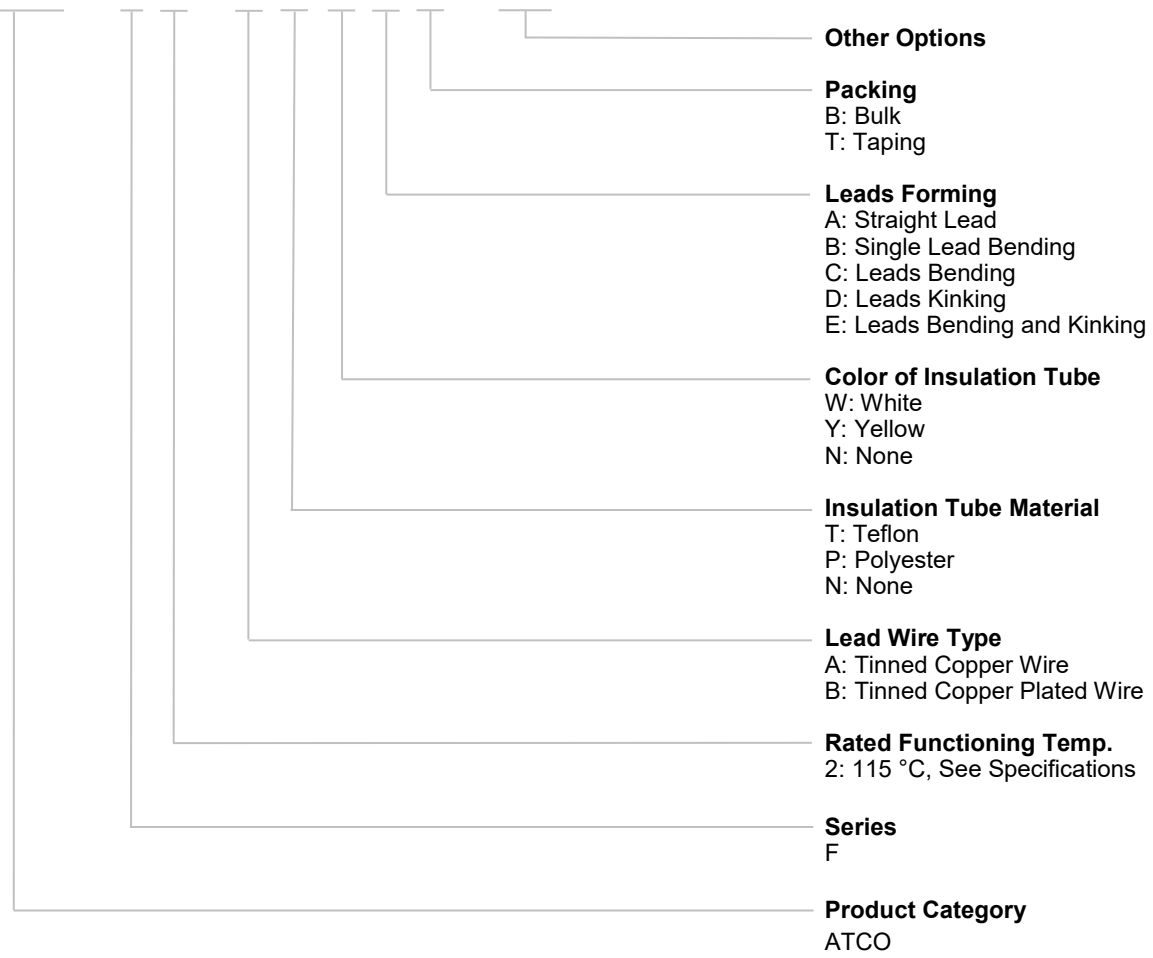

### Leads Forming Types







The below leads forming is for reference, more leads forming can be customized.

A	B	C	D	E
Straight Lead	Single Lead Bending	Leads Bending	Leads Kinking	Leads Bending and Kinking

## Glossary

Item	Description
<b>TCO</b>	<b>Thermal-Link</b> A non-resettable device incorporating a THERMAL ELEMENT which will open a circuit once only when exposed for a sufficient length of time to a temperature in excess of that for which it has been designed.
<b>ATCO</b>	<b>Alloy Thermal-Link</b> Alloy Type Thermal-Link, Alloy is the thermal element.
$T_f$	<b>Rated Functioning Temp.</b> The temperature of the Alloy Thermal-Link which causes it to change the state of conductivity with a detection current up to 10 mA as the only load. Tolerance: $T_f \pm 10^\circ C$ (GB/T 9816, EN 60691, K60691). Tolerance: $T_f \pm 7^\circ C$ (J60691).
<b>Fusing Temp.</b>	<b>Fusing Temp.</b> The temperature of the Alloy Thermal-Link which causes it to change its state of conductivity is measured with silicone oil bath in which the temperature is increased at the rate of 0.5 °C to 1 °C / minute, with a detection current up to 10 mA as the only load.
$T_h$	<b>Holding Temp.</b> The Maximum temperature at which a Alloy Thermal-Link will not change its state of conductivity when conducting rated current for 168 hours.
$T_m$	<b>Maximum Temp. Limit</b> The temperature of the Alloy Thermal-Link stated by the manufacturer, up to which the mechanical and electrical properties of the Alloy Thermal-Link having changed its state of conductivity, will not be impaired for a given time.
$I_r$	<b>Rated Current</b> The current used to classify a Alloy Thermal-Link, which is the Maximum current that Alloy Thermal-Link allows to carry and is able to cut off the circuit safely.
$U_r$	<b>Rated Voltage</b> The voltage used to classify a Alloy Thermal-Link, which is the Maximum voltage that Alloy Thermal-Link allows to carry and is able to cut off the circuit safely.
<b>CP Wire</b>	<b>CP Wire</b> Tinned Copper Plated Wire

### Specifications

Model	$T_f$	Fusing Temp.	$T_h$	$T_m$	$I_r$	$U_r$								RoHS, REACH
	(°C)	(°C)	(°C)	(°C)	(A)	(V)	UL	cUL	TUV	VDE	PSE	KC	CCC	
F0	76	73 ± 2	53	200	1	AC 250	●	●	●	○	●	○	●	●
F18	86	81 ± 2	61	200	1	AC 250	●	●	●	○	●	○	●	●
			50		3	DC 60	●	●	●	○	○	○	○	●
F1	102	98 ± 2	79	200	1	AC 250	●	●	●	●	●	●	●	●
			60		3	DC 60	●	●	●	○	○	○	○	●
F2	115	111 ± 2	91	200	1	AC 250	●	●	●	●	●	●	●	●
			80		3	DC 60	●	●	●	○	○	○	○	●
F3	125	121 ± 2	100	200	1	AC 250	●	●	●	●	●	●	●	●
F4	130	125 ± 2	106	200	1	AC 250	●	●	●	●	●	●	●	●
			90		3	DC 60	●	●	●	○	○	○	○	●
F8	133	130 ± 2	111	200	1	AC 250	●	●	●	●	●	●	●	●
			90		3	DC 60	●	●	●	○	○	○	○	●
F13	139	135 ± 2	95	200	1	AC 250	●	●	●	○	●	○	○	●
					3	DC 60	●	●	●	○	○	○	○	●
F6	145	140 ± 2	121	200	1	AC 250	●	●	●	○	●	○	○	●
			115		3	DC 60	●	●	●	○	○	○	○	●
F7	150	145 ± 2	126	200	1	AC 250	●	●	●	●	●	●	●	●
F16	160	154 ± 2	135	200	1	AC 250	○	○	○	○	●	○	●	●

Note:

"●"Means certificated.

"○"Means non-certificated.

## Product Temp.-Time Curve (Reference)

The Temp.-Time Curve of Thermal-Link in different temp. oil bath.

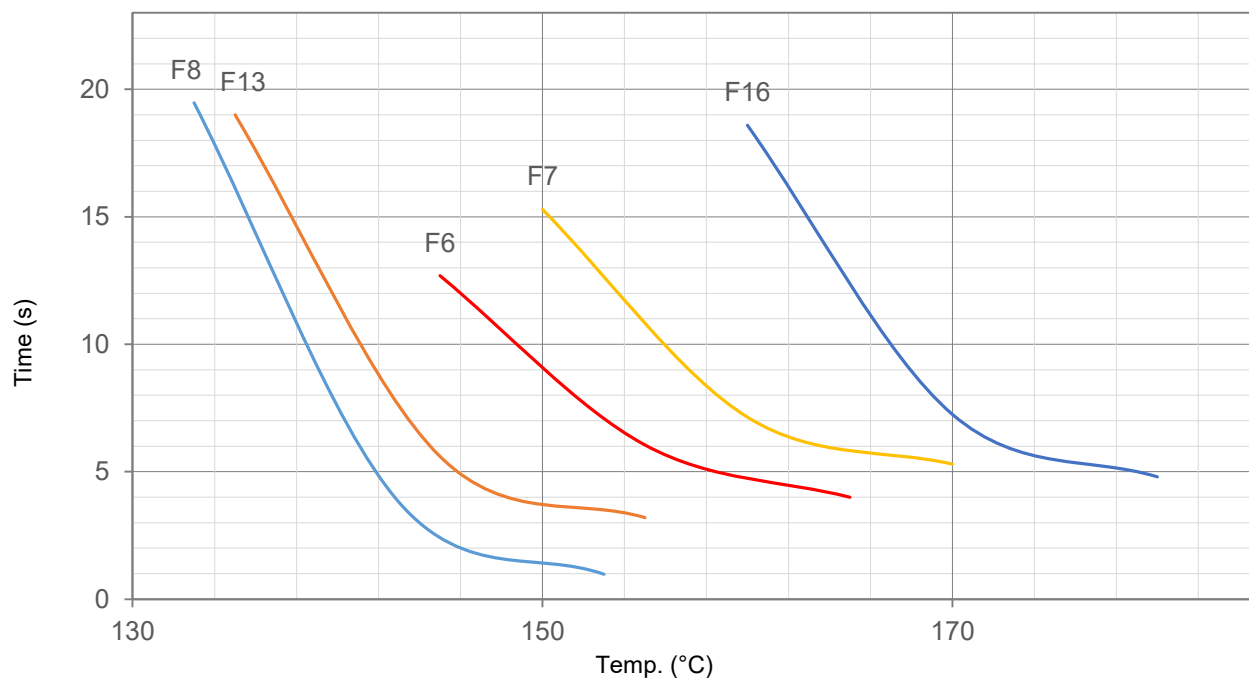
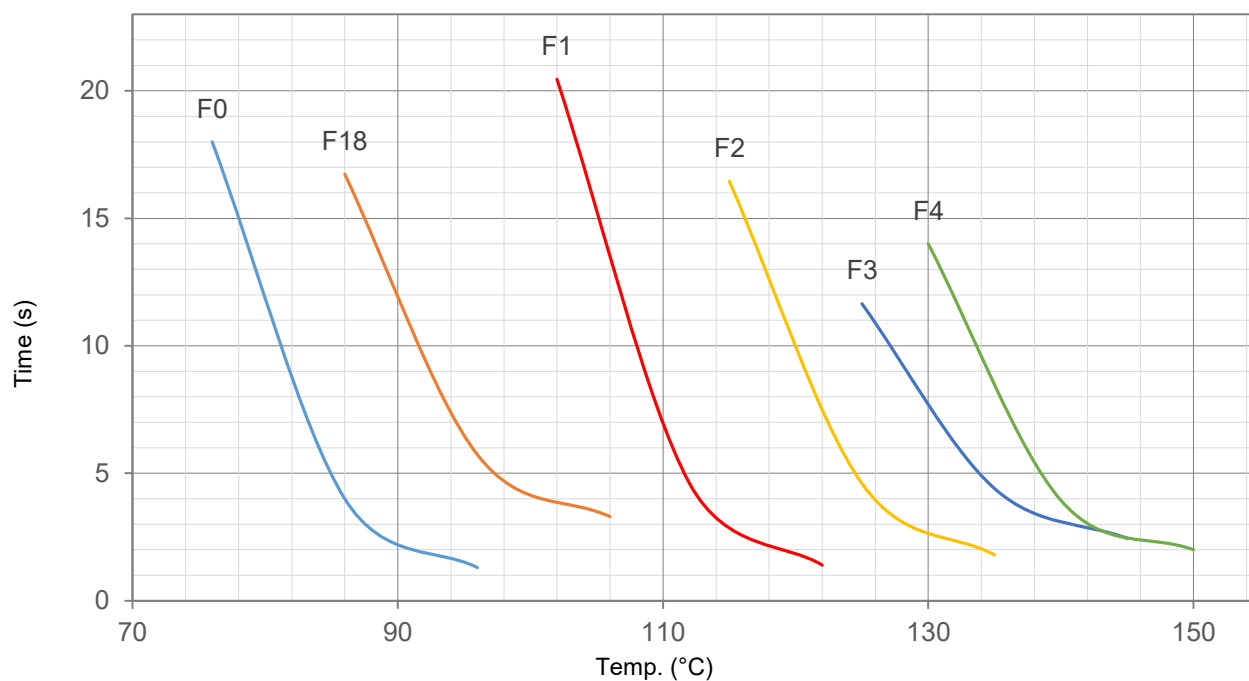

## Product Current-Time Curve (Reference)

The Current-Time Curve shows functioning time at multi-times rated current at room temperature  $25 \pm 2 \text{ }^\circ\text{C}$ .

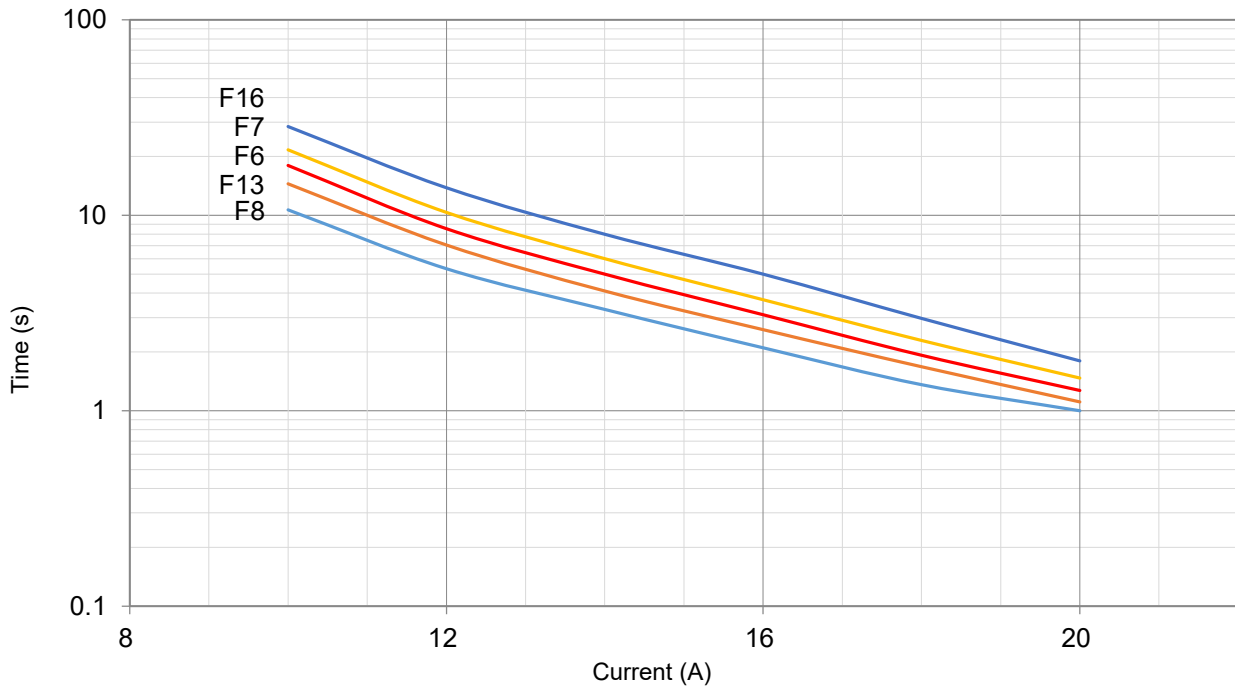
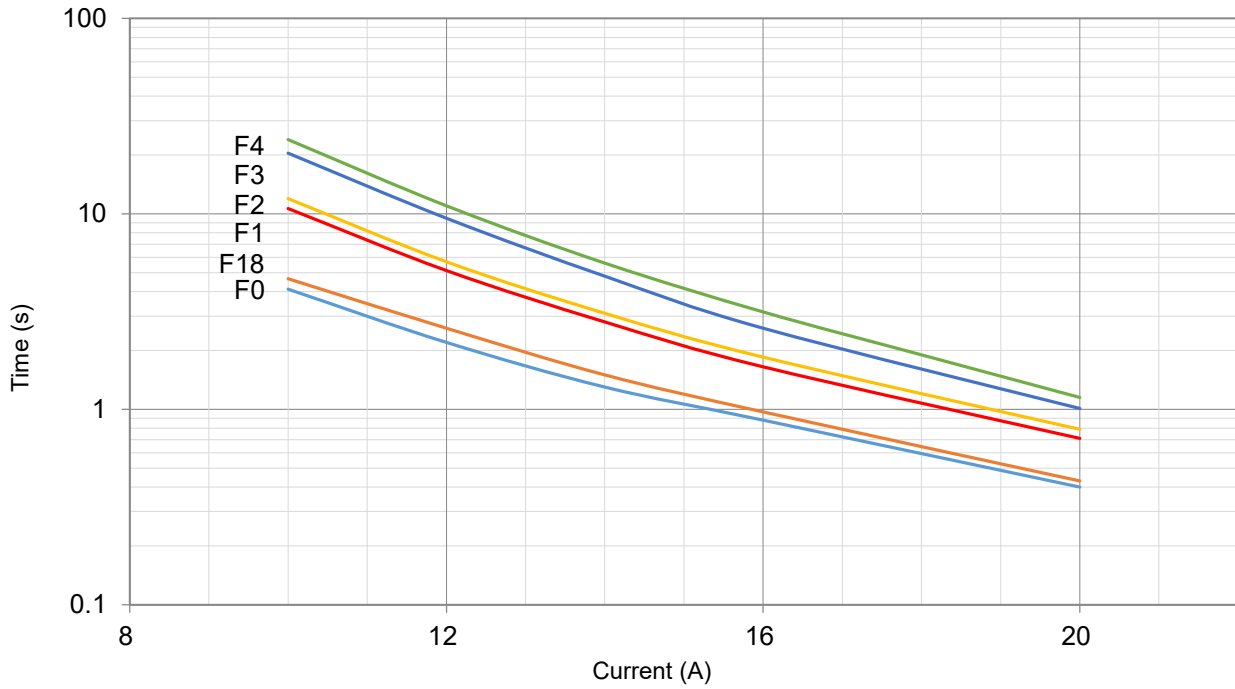

ATCO

ATCO

## Packaging Information

Bulk

Item	PE Bag	PE Bag	Carton
Dimensions (mm)	135 × 85	190 × 180	440 × 300 × 260
Quantity (PCS)	100	1000	50000
Gross Weight (kg)			17 ± 10%

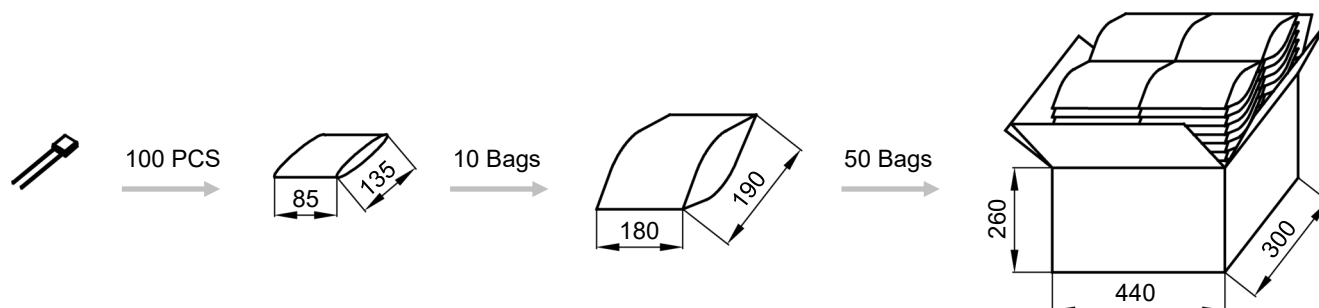



Taping

Item	Box	Carton
Dimensions (mm)	328 × 200 × 70	480 × 340 × 220
Quantity (PCS)	2000	12000
Gross Weight (kg)		5.6 ± 10%

ATCO

ATCO

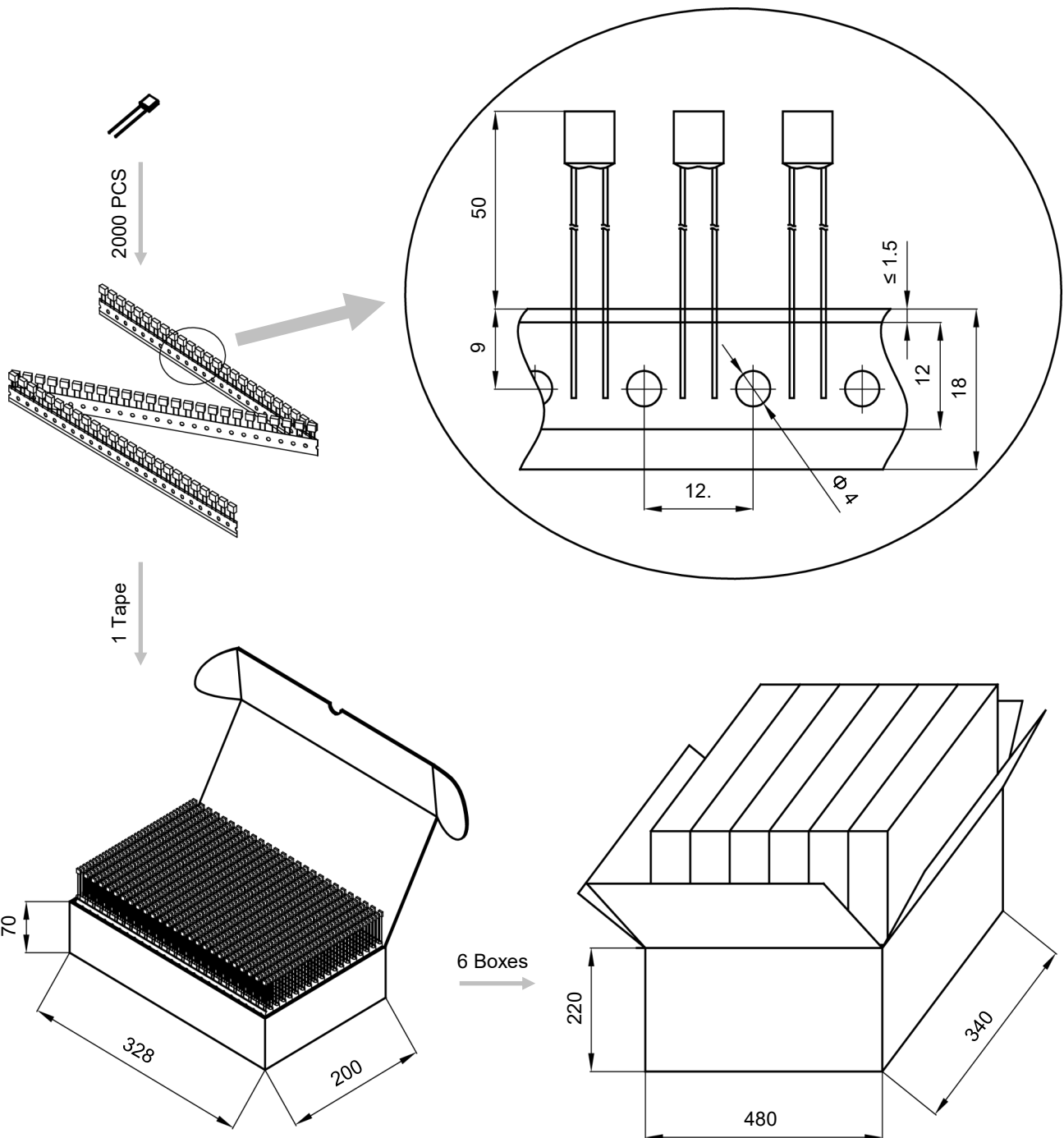



# ATTENTION

## Usage

1. When atmosphere pressure is from 80 kPa to 106 kPa, the related altitude shall be from 2000 meter to - 500 meter.
2. Operating voltage less than rated voltage of ATCO, operating current less than rated current of ATCO.
3. Do not touch the ATCO body or lead wires directly when power is on, to avoid burn or electric shock.

## Replace

ATCO is a non-repairable product. For safety sake, it shall be replaced by an equivalent ATCO from the same manufacturer, and mounted in the same way.

## Storage

Do not store the ATCO at the high temp., high humidity or corrosive gas environment, avoid influencing the solder-ability of the lead wires, the product shall be used up within 1 year after receiving the goods.

## Installation

Make Sure the Temp. of Installation Position.

1. It is recommended that a dummy ATCO with inbuilt thermo-couple shall be used to determine the proper temp.
2. The terminal product should be tested to ensure that potential abnormal conditions do not cause ambient temp. to exceed the  $T_m$  of the ATCO.
3. Mount the ATCO at the location where temp. rises evenly.

Installation position of mechanical performance requirements.

1. Do not locate the ATCO in a place where severe vibration always occurs.
2. Ensure that the lead wire is long enough, and avoid actions such as press, tensile or twist.
3. The seal or body of ATCO must not be damaged, burned or over heated.

## Mechanical Connection

### Riveting

1. Choose small resistivity riveting material and be riveted.
2. A flexible lead or lead with low resistance should be used to rivet the ATCO.
3. Contact resistance should be minimal, Large contact resistance will lead to higher temp., ATCO Functioning in advance.

## Soldering

### Hand-Soldering

1. Soldering should be carried out according to Table F-1.
2. The thermal element of ATCO is fusible alloy with low melting point, which is jointed with ATCO lead wires. Improper soldering operation (too high soldering temp. , too long soldering time, too short lead wire etc.) may transfer more heat to the thermal element and ATCO may open in advance.
3. When soldering conditions are more severe than those listed in Table F-1, a heat sink fixture should be used between soldering point and ATCO body.
4. When soldering, please do not pull / push or twist ATCO body or lead wires.
5. After soldering, let it naturally cool for longer than 20 seconds. During cooling, never move the ATCO body or lead wires.

### Wave Soldering

The wave soldering parameters as Table F-2, for reference only, when ATCO is for practice use, you need to do some validation experiments. For example, using X-RAY to see the fusible alloy of ATCO whether damage after wave soldering.

**TABLE F-1** Hand-Soldering Time

Rated Functioning Temp. ( $T_f$ )	Max. Allowable Soldering Time for Different Lead Wire Length (Fig.F-1)									Max. Soldering Temp.
	$L_s$ Length	Time		$L_s$ Length	Time		$L_s$ Length	Time		
		Tinned Copper Wire	CP Wire		Tinned Copper Wire	CP Wire		Tinned Copper Wire	CP Wire	
(°C)	(mm)	(s)	(s)	(mm)	(s)	(s)	(mm)	(s)	(s)	(°C)
76 to 101	10	1 <sup>a</sup>	4	20	2	5	30	3	6	400
102 to 115	10	1 <sup>a</sup>	4	20	2	5	30	3	6	
116 to 135	10	1 <sup>a</sup>	4	20	3	6	30	5	8	
136 to 150	10	3	6	20	5	8	30	5	8	
151 to 230	10	4	7	20	6	9	30	7	10	

Note:

a: Auxiliary Heat Sink Fixture is Required to Avoid ATCO Cutting off Unexpectedly.

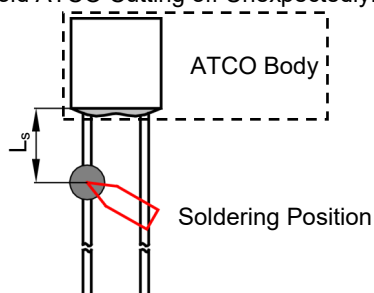

**FIGURE F-1**

**TABLE F-2** Wave Soldering Parameters Setting

Rated Functioning Temp. ( $T_f$ )	Max. Allowable Preheating Temp. When the Length of Lead Wire is Different (Fig.F-1)				Preheating Time ( $t_1$ )	Max. Wave Soldering Temp.	Dwelling Time ( $t_2$ )	Cooling Time ( $t_3$ )
	$L_s$ Length	Preheating Temp.	$L_s$ Length	Preheating Temp.				
(°C)	(mm)	(°C)	(mm)	(°C)	(s)	(°C)	(s)	(s)
76 to 130	Recommend Hand-Soldering							
131 to 150	20	80	30	90	< 60	≤ 260	≤ 3	≤ 10
151 to 230	20	90	30	100	< 60	≤ 260	≤ 3	≤ 10

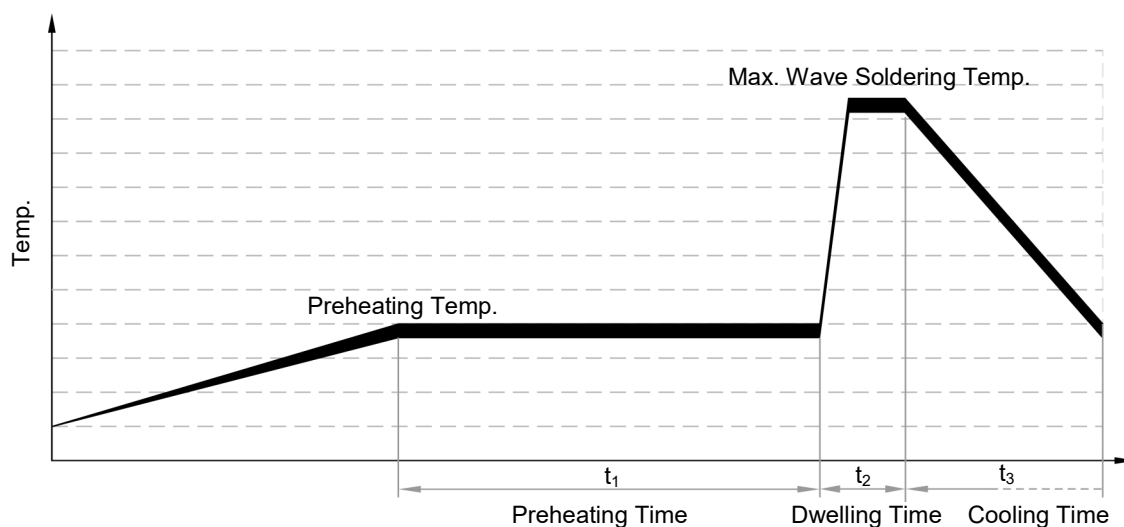

### Lead Wire Forming

1. If lead wire has to be bent, please pay attention to the distance between body and bending point. Refer to Table F-3.
2. When bending leads, please use pincher or similar tools to fix the product as shown in Fig.F-2, to avoid damaging the product.
3. During forming and mounting, lead wire should not be cut, nicked, bent sharply, to avoid breaking the product.
4. Tangential forces on the leads must be avoided (i.e. pushing or pulling on the leads at angle to ATCO body) as such forces may damage the seal of ATCO.

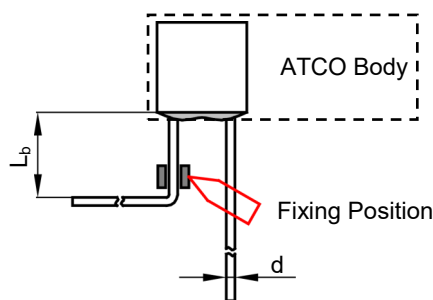

**FIGURE F-2**

**TABLE F-3** Distance between Body and Bending Point

d	(mm)	≤ 1.0	1.0 to 1.2	> 1.2
$L_b$	(mm)	≥ 3	≥ 5	≥ 10